

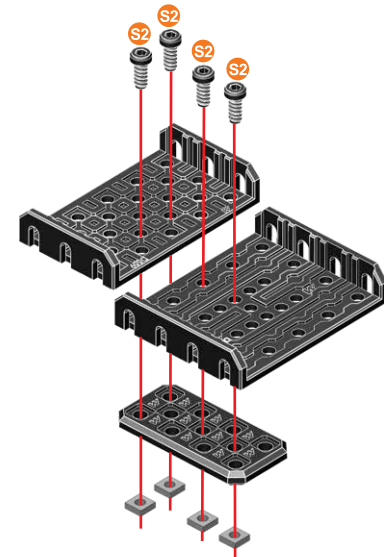

1

- | 9.5 mm | 3/8" | x4
- | x4
- | x1
- | x1
- | x1

- | 1:1



2

- | 9.5 mm | 3/8" | x4
- | 12 mm | 1/2" | x2
- | x6
- | x2
- | x2

- | 1:1
- | 1:1

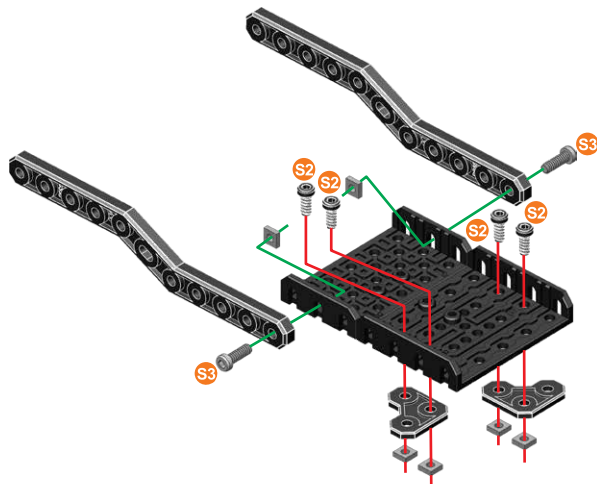



3

- | 9.5 mm | 3/8" | x4
- | 12 mm | 1/2" | x2
- | x6
- | x2
- | x1

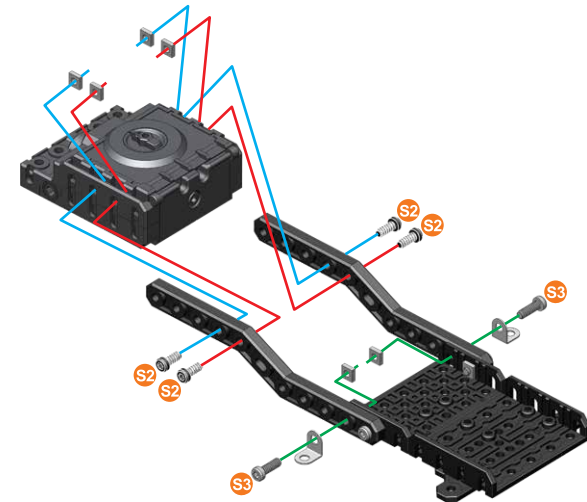
- | 1:1
- | 1:1



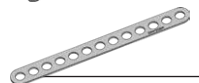

4

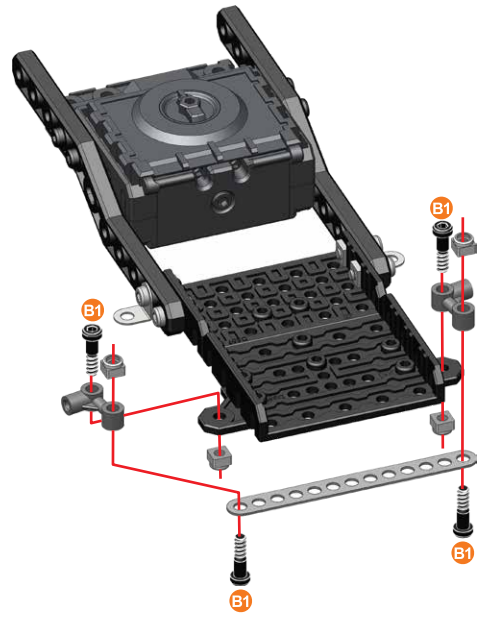
-  **B1** | 14.7 mm | **x4**
37/64"
-  **x4**
-  **x2**
-  **x1**







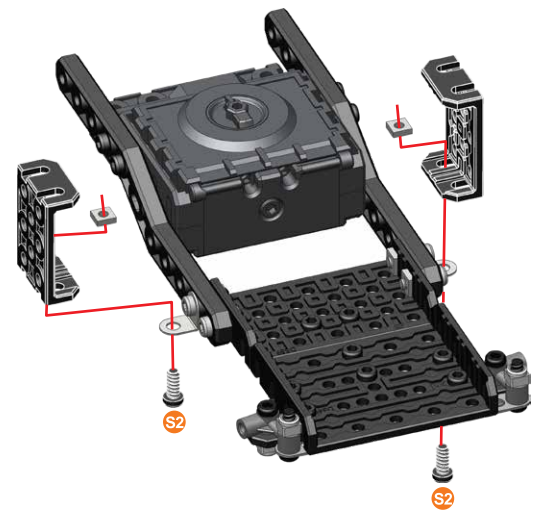

5

-  **S2** | 9.5 mm | **x2**
3/8"
-  **x2**
-  **x2**





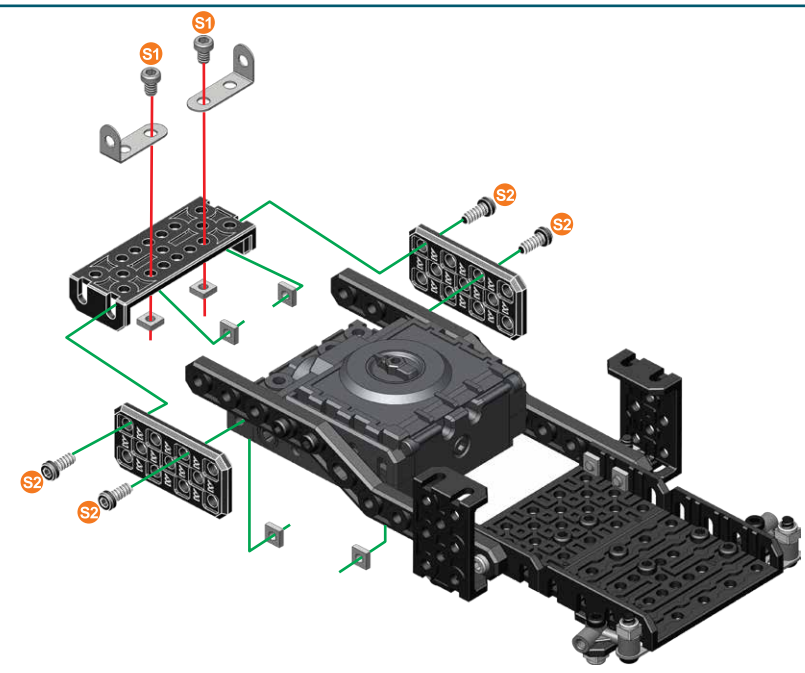

6

-  **S1** | 5.8 mm | **x2**
15/64"
-  **S2** | 9.5 mm | **x4**
3/8"
-  **x6**
-  **x2**
-  **x2**
-  **x1**





7

-  S1 | 5.8 mm | x2
15/64"
-  S5 | 25.4 mm | x2
1"
-  | x4
-  | x1
-  | x1
-  | x2

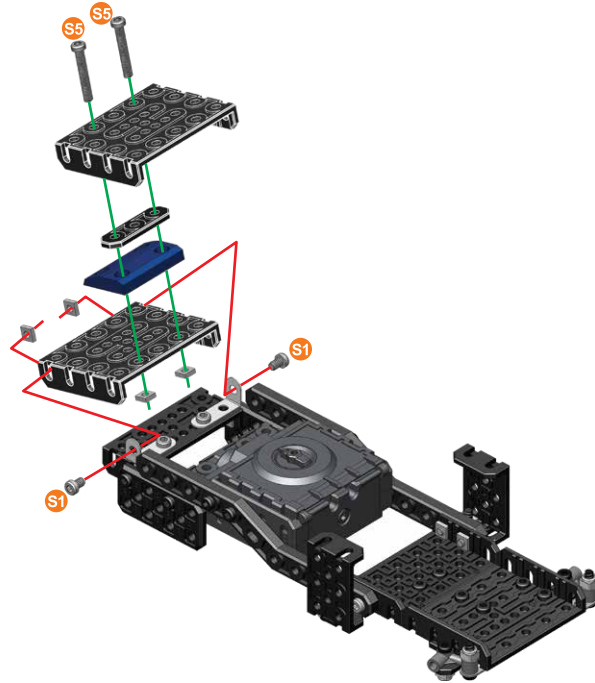





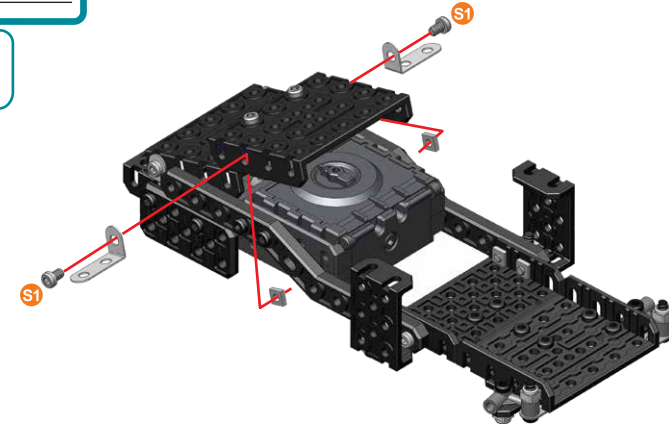

-  S1
-  S5
- 1:1



**8**

-  S1 | 5.8 mm | x2
15/64"
-  | x2
-  | x2





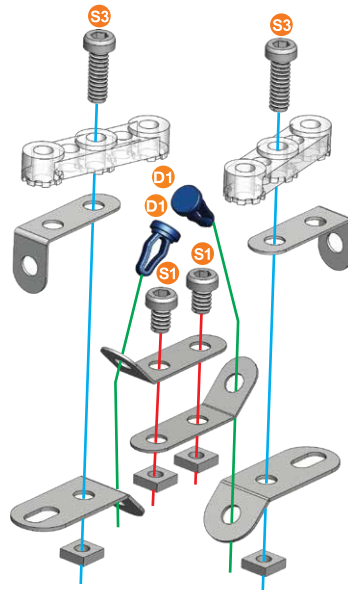

-  S1
- 1:1

**9**

-  D1 | 11.25 mm | x2
7/16"
-  S1 | 5.8 mm | x2
15/64"
-  S3 | 12 mm | x2
1/2"
-  | x4
-  | x2
-  | x2
-  | x2
-  | x2

-  D1
-  S1
-  S3
- 1:1







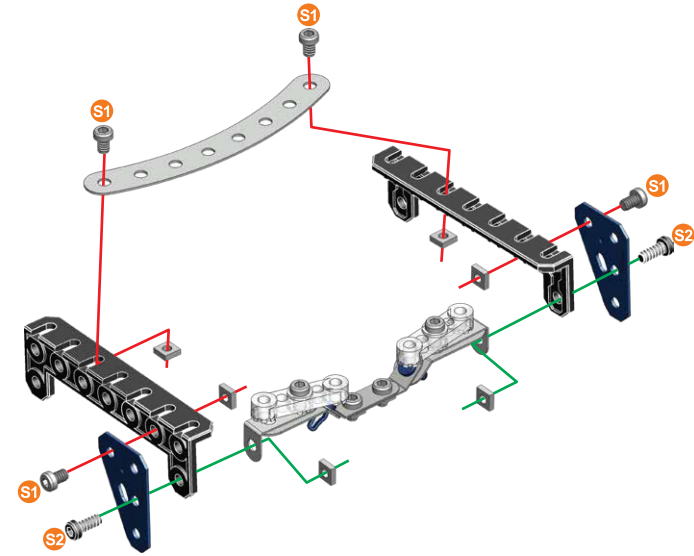

**10**

-  S1 | 5.8 mm | x4
15/64"
-  S2 | 9.5 mm | x2
3/8"
-  | x6
-  | x2
-  | x1
-  | x2

-  S1
-  S2
- 1:1







11

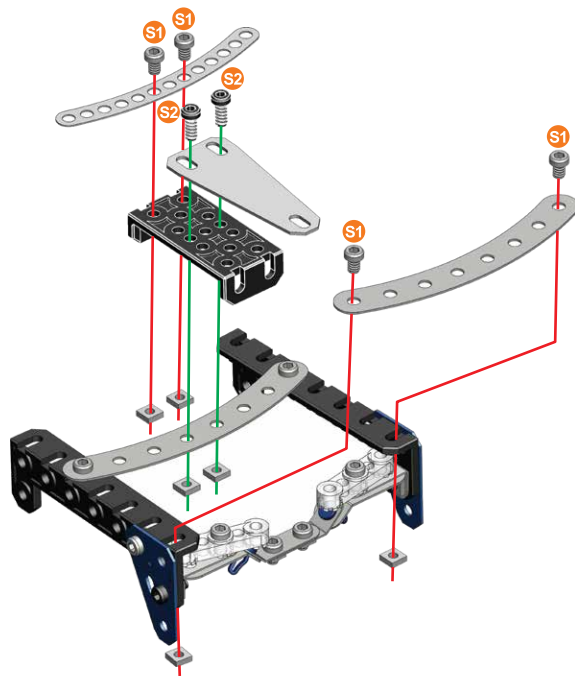

-  **S1** | 5.8 mm | 15/64" | **x4**
-  **S2** | 9.5 mm | 3/8" | **x2**
-  | **x6**
-  | **x1**
-  | **x1**
-  | **x1**
-  | **x1**
-  | **x1**

- | | | |
|---|-----------|------------|
|  | S1 | 1:1 |
|  | S2 | |







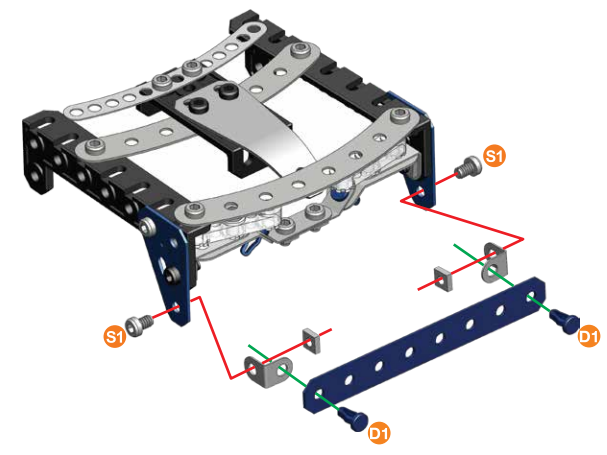

12



-  **D1** | 11.25mm | 7/16" | **x2**
-  **S1** | 5.8 mm | 15/64" | **x2**
-  | **x2**
-  | **x2**
-  | **x1**

- | | | |
|---|-----------|------------|
|  | D1 | 1:1 |
|  | S1 | |





13

-  **S1** | 5.8 mm | 15/64" | **x2**
-  **S3** | 12 mm | 1/2" | **x2**
-  | **x4**
-  | **x2**
-  | **x2**
-  | **x2**

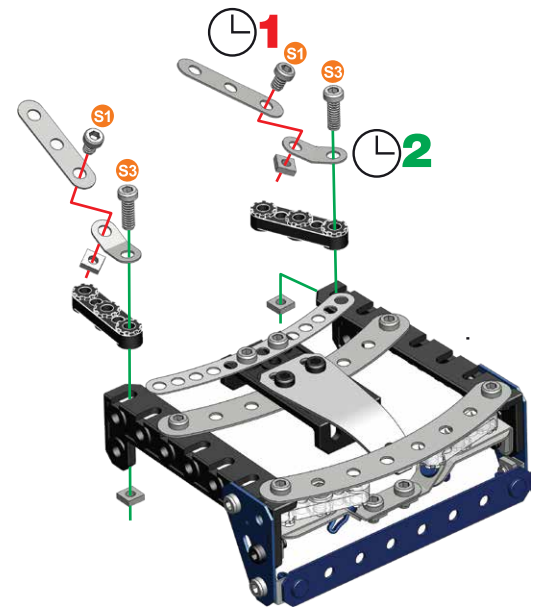
- | | | |
|---|-----------|------------|
|  | S1 | 1:1 |
|  | S3 | |





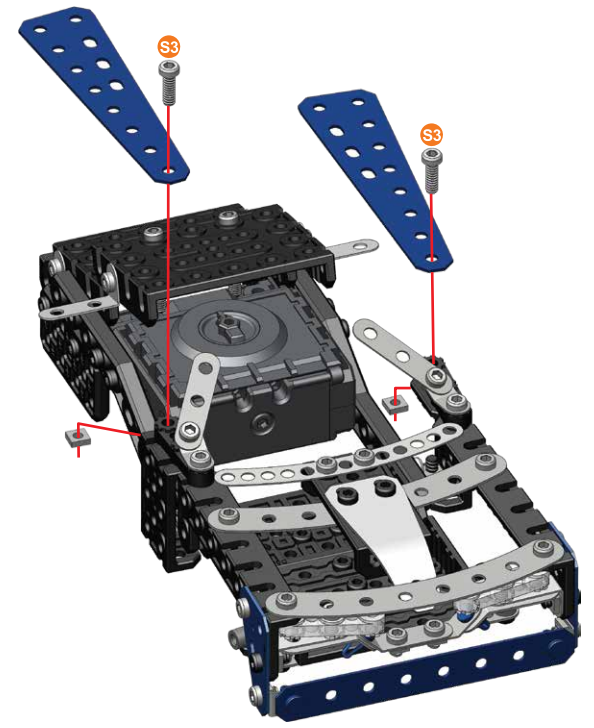

14

- 8+13+**
-  **S3** | 12 mm | 1/2" | **x2**
 -  | **x2**

- | | | |
|---|-----------|------------|
|  | S3 | 1:1 |
|---|-----------|------------|





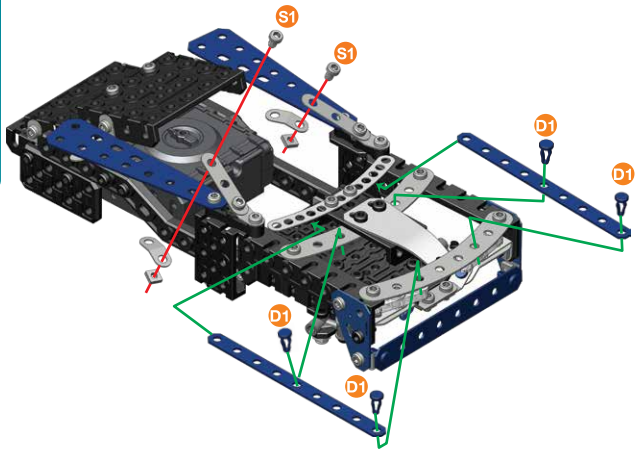

15

-  **D1** | 11,25mm | **x4**
7/16"
-  **S1** | 5,8 mm | **x2**
15/64"
-  | **x2**
-  | **x2**
-  | **x2**







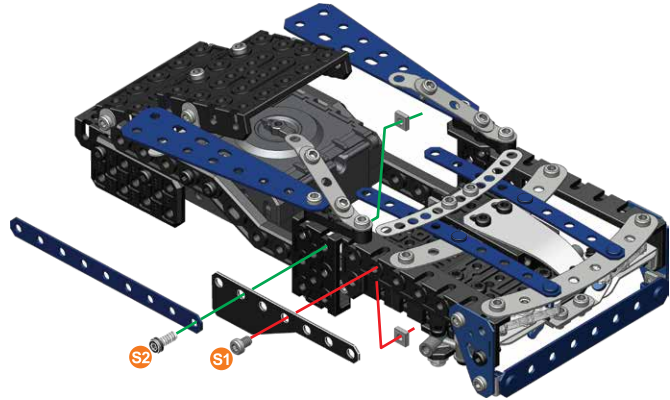

16

-  **S1** | 5,8 mm | **x1**
15/64"
-  **S2** | 9,5 mm | **x1**
3/8"
-  | **x2**
-  | **x1**
-  | **x1**



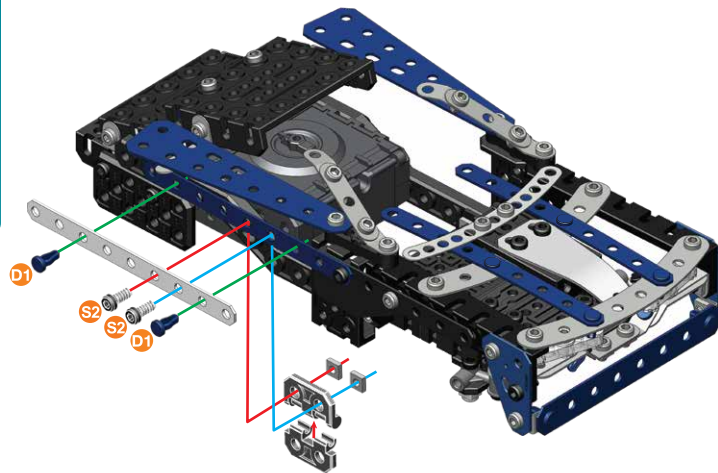
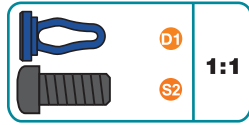

17

-  **D1** | 11,25mm | **x2**
7/16"
-  **S2** | 9,5 mm | **x2**
3/8"
-  | **x2**
-  | **x1**
-  | **x1**
-  | **x1**







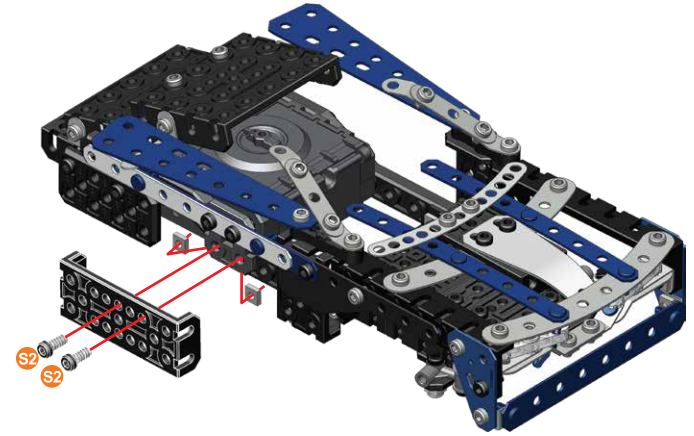





18



-  **S2** | 9,5 mm | **x2**
3/8"
-  | **x2**
-  | **x1**



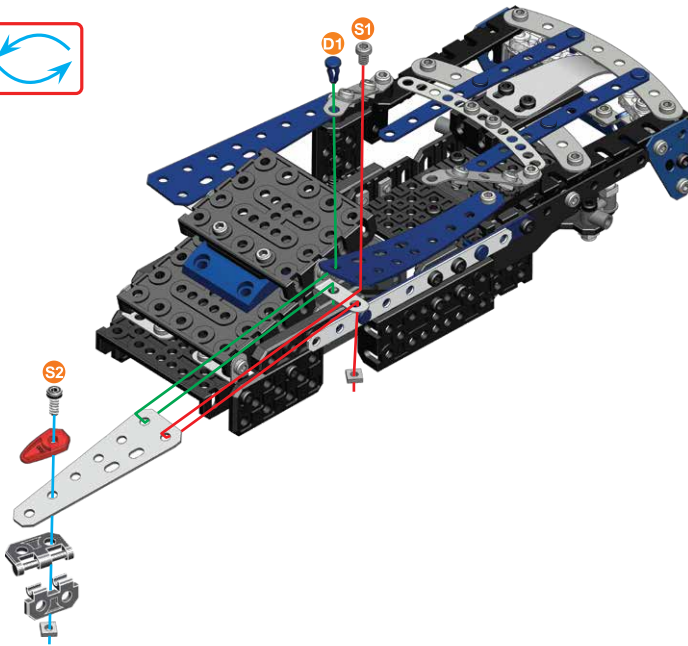

19

-  **D1** | 11.25mm | **x1**
7/16"
-  **S1** | 5.8 mm | **x1**
15/64"
-  **S2** | 9.5 mm | **x1**
3/8"
-  **x2**
-  **x1**
-  **x1**
-  **x1**
-  **x1**
-  **x1**
-  **x1**



-  **D1**
-  **S1** | **1:1**
-  **S2**



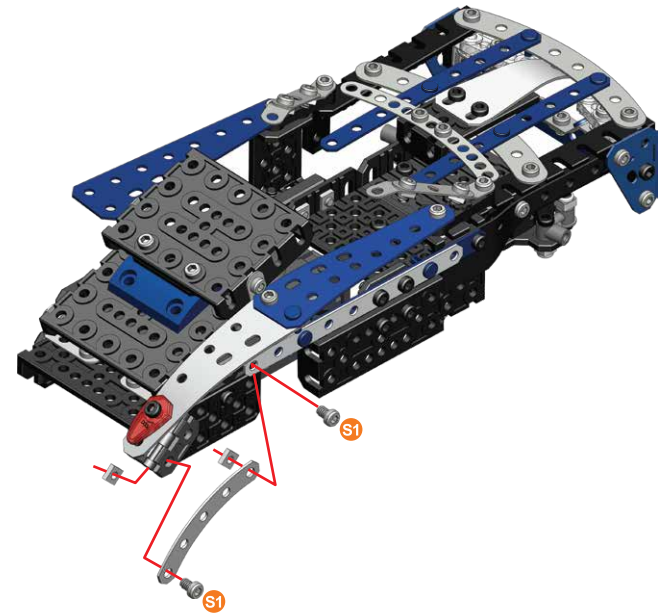

20

-  **S1** | 5.8 mm | **x2**
15/64"
-  **x2**
-  **x1**

-  **S1** | **1:1**







21

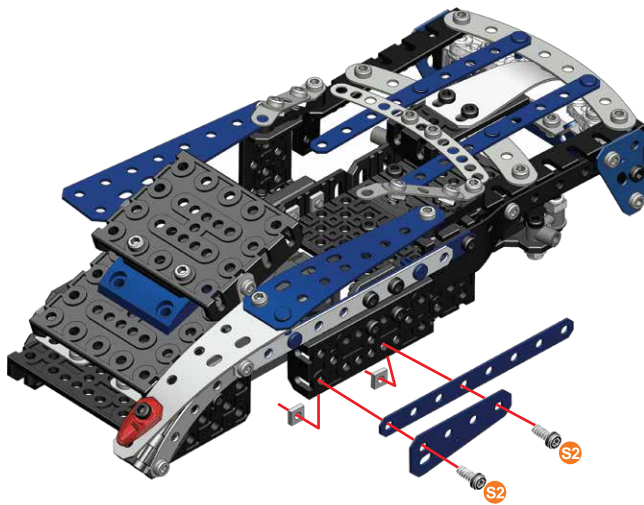

-  **S2** | 9.5 mm | **x2**
3/8"
-  **x2**
-  **x1**
-  **x1**

-  **S2** | **1:1**









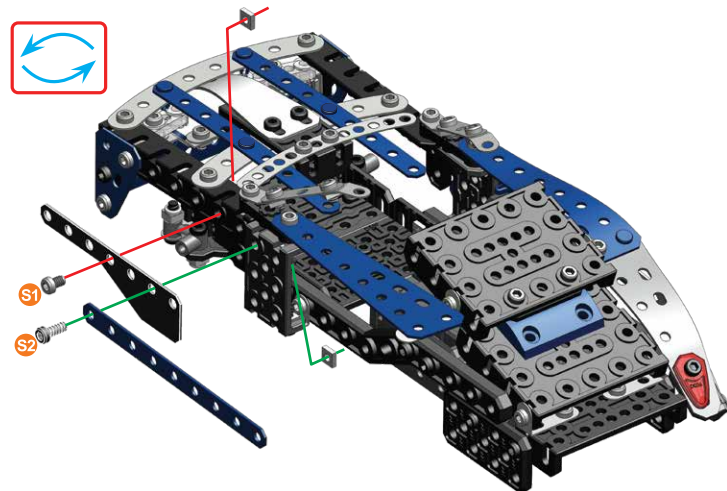

22



-  **S1** | 5.8 mm | **x1**
15/64"
-  **S2** | 9.5 mm | **x1**
3/8"
-  **x2**
-  **x1**
-  **x1**

-  **S1**
-  **S2** | **1:1**







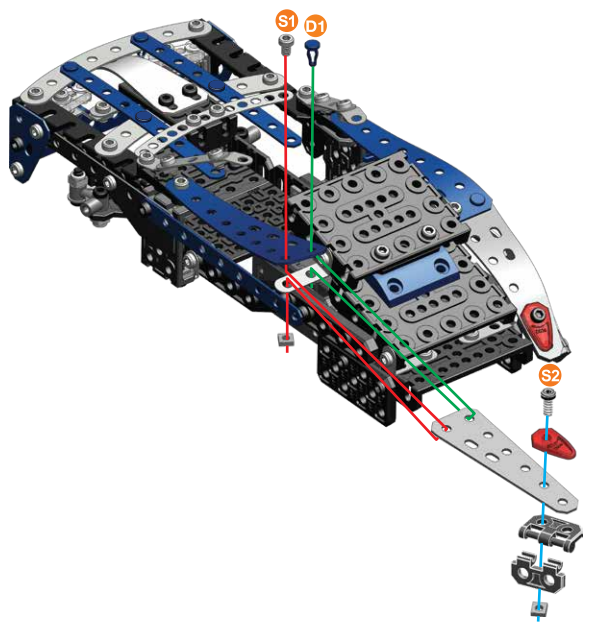

23



-  **D1** | 11,25mm | **x1**
7/16"
-  **S1** | 5,8 mm | **x1**
15/64"
-  **S2** | 9,5 mm | **x1**
3/8"
-  | **x2**
-  | **x1**
-  | **x1**
-  | **x1**
-  | **x1**

- | | | |
|---|-----------|------------|
|  | D1 | 1:1 |
|  | S1 | |
|  | S2 | |





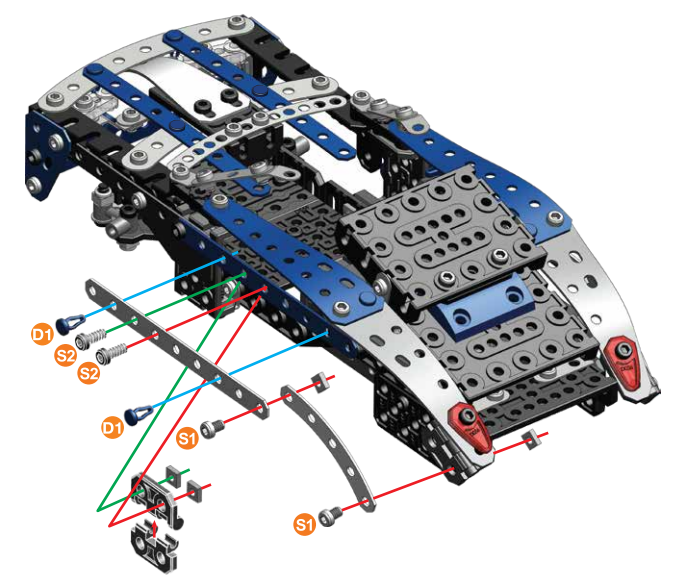

24

-  **D1** | 11,25mm | **x2**
7/16"
-  **S1** | 5,8 mm | **x2**
15/64"
-  **S2** | 9,5 mm | **x2**
3/8"
-  | **x4**
-  | **x1**
-  | **x1**
-  | **x1**

- | | | |
|---|-----------|------------|
|  | D1 | 1:1 |
|  | S1 | |
|  | S2 | |







25

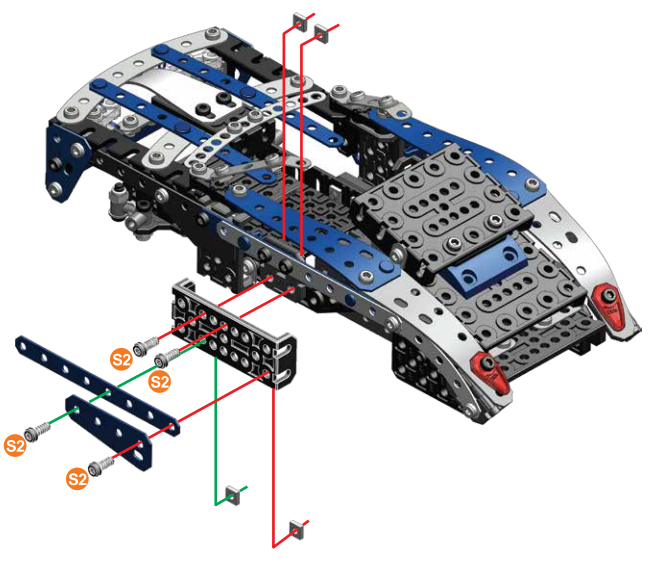

-  **S2** | 9,5 mm | **x4**
3/8"
-  | **x4**
-  | **x1**
-  | **x1**
-  | **x1**

- | | | |
|---|-----------|------------|
|  | S2 | 1:1 |
|---|-----------|------------|



26

-  **D1** | 11,25mm | **x2**
7/16"
-  **S1** | 5,8 mm | **x2**
15/64"
-  | **x2**
-  | **x1**
-  | **x2**

- | | | |
|---|-----------|------------|
|  | D1 | 1:1 |
|  | S2 | |

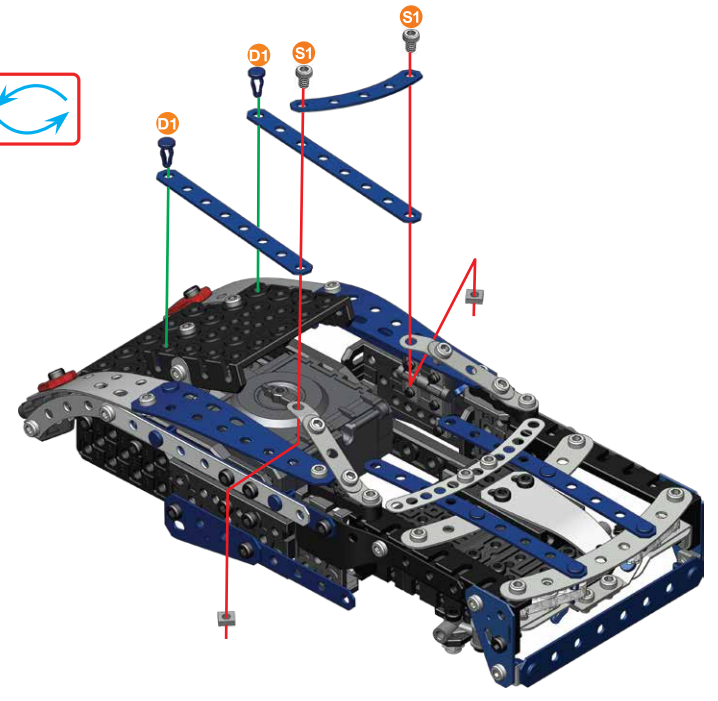

27

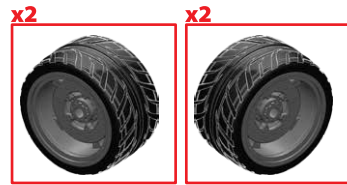
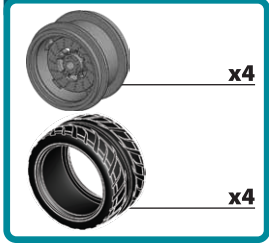

28

26+27+

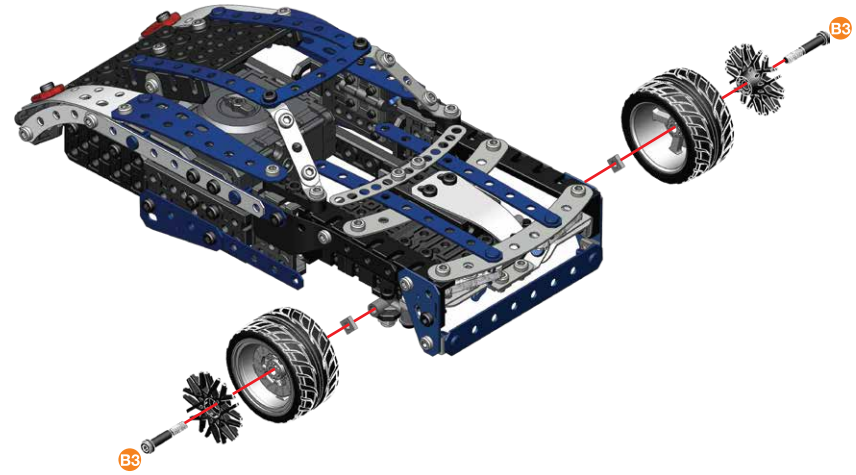
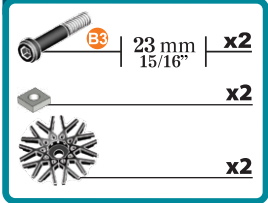

29

27+28+

